

**EXTREM-KER®**

**TEJAS BORJA**  
Únicos desde 1899

*Francisco Ramón Borja*

**TEJAS BORJA**  
Únicos desde 1899

*Francisco Ramón Borja*

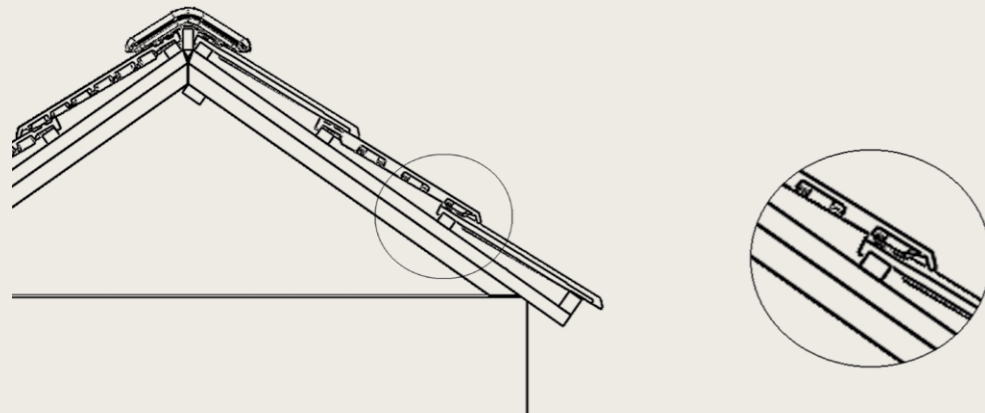

SOLAPE VARIABLE DE 35 A 38 cm / VARIABLE OVERLAP FROM 35 TO 38 cm / PUEAU UTILE VARIABLE DU 35 A 38 cm.

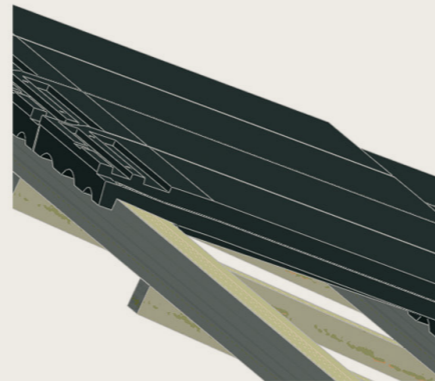
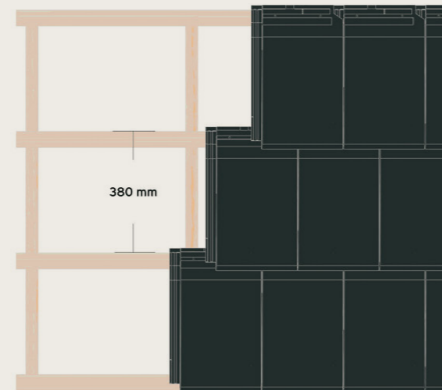
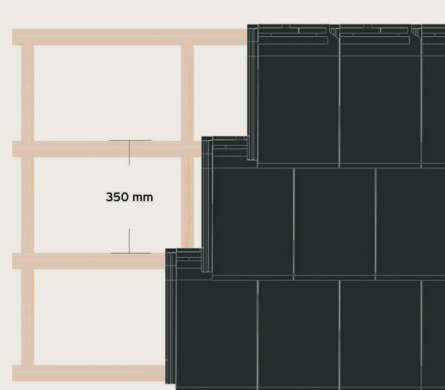

Distancia mín. rastrel: 35,0 cm.  
11 uds/m<sup>2</sup>  
Pendiente mín.: < 42%  
Lámina impermeable

Minimum batten distance: 35,0 cm.  
11 units per sq.m.  
Minimum slope: < 42%  
Waterproof layer

Distance de liteau minimum: 35,0 cm.  
11 unités m<sup>2</sup>  
Pente minimal: < 42%  
Écran imperméable

Distancia máx. rastrel: 38,0 cm.  
10 uds/m<sup>2</sup>  
Pendiente mín.: ≥ 42%  
Lámina ligera transpirable para prevenir condensaciones

Maximum batten distance: 38,0 cm.  
10 units per sq.m.  
Minimum slope: ≥ 42%  
Waterproof and breathing layer

Distance de liteau maximum: 38,0 cm.  
10 unités par m<sup>2</sup>  
Pente minimal: ≥ 42%  
Écran imperméable prevention condensations

Fijación: Mayor estabilidad con tetones de apoyo sobre rastrel en línea

Installation: Greater stability with batten lugs in line  
Installation: Grande stabilité avec des tenons pour l'appui sur liteaux

Info:  
+34 902 200 909  
e-mail: [info@tejasborja.es](mailto:info@tejasborja.es)  
[export@tejasborjas.es](mailto:export@tejasborjas.es)

SPAIN

VALENCIA. Ctra. Lliria a Pedralba km.3  
46160 Lliria (Valencia)  
Tel. +34 96 279 80 14 - Fax. +34 96 278 25 63  
[www.tejasborja.com](http://www.tejasborja.com)

**EXTREM-KER®**  
PERFECT TECHNOLOGY

**Flat 10**

La primera teja de Gres  
The first gres roof tile  
La première tuile en grès

Absorción: < 3% - Planeidad: Máxima - Ligera: 37 Kg./m2

Water absorption: < 3% - Flatness: Maximum - Light weight: 37 Kg./sq.m.

Absorption d'eau: < 3% - Planéité: Maximal - Légère: 37 Kg./m2.



## Flat 10

### Características\*

Longitud: 45,1 cm.

Anchura: 28,7 cm.

Peso: 3,70 Kg.

Unidades por m2: 11 uds. ó 10 uds.

Unidades por ml alero: 4 uds.

Longitud útil VARIABLE: de 35,0 cm. a 38,0 cm.

\*Valores aproximados: será necesario determinar la longitud útil en obra. < 42% distancia entre rastreles 35,0 cm (11 uds/m2) - lámina impermeable | ≥ 42% distancia entre rastreles 38,5 cm. (10 uds/m2) - lámina transpirable para prevenir condensaciones.

### Characteristics\*

Length: 45,1 cm.

Width: 28,7 cm.

Weight: 3,70 Kg.

Units per sq.m.: 10 units/11 units

Units per LM eave: 4 units

Useful length VARIABLE: from 35,0 cm. to 38,0 cm.

\*Approximate values: it will be necessary to determine the useful length on site. < 42% batten distance 35,0 cm (11 units/sq.m.) - waterproof layer | ≥ 42% batten distance 38,5 cm. (10 units/sq.m.) - waterproof and breathing layer to prevent condensations.

### Caractéristiques\*

Longueur: 45,1 cm.

Largeur: 28,7 cm.

Poids: 3,70 Kg.

Unités par m2: 10 unités/11 unités

Unités par ML égout: 4 unités

Pureau utile VARIABLE: 35,0 cm. - 38,0 cm.

\*Valeurs approximatives: il sera nécessaire de déterminer la pureau utile sur chantier. < 42% distance de l'iteau 35,0 cm (11 unités/m2) - écran imperméable | ≥ 42% distance de l'iteau 38,5 cm. (10 unités/m2) - écran imperméable pour éviter des condensations.

Disponible en acabado LEON / Available in LEON finish / Disponible en finition LEON

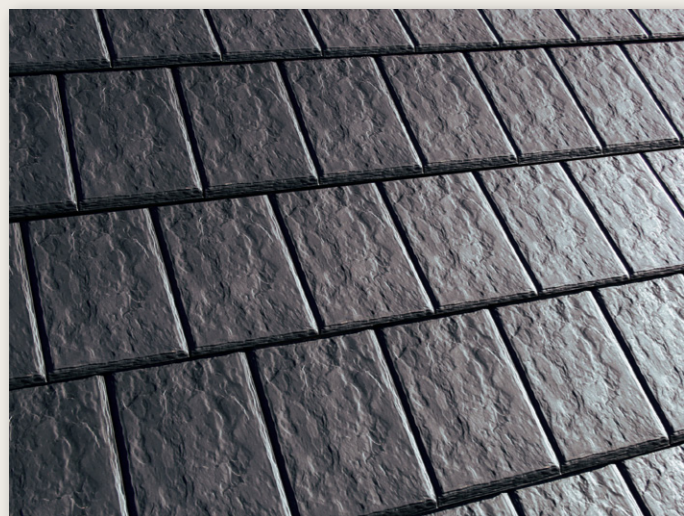

Colocación al trebolillo / Staggered placement / Pose en quinconce

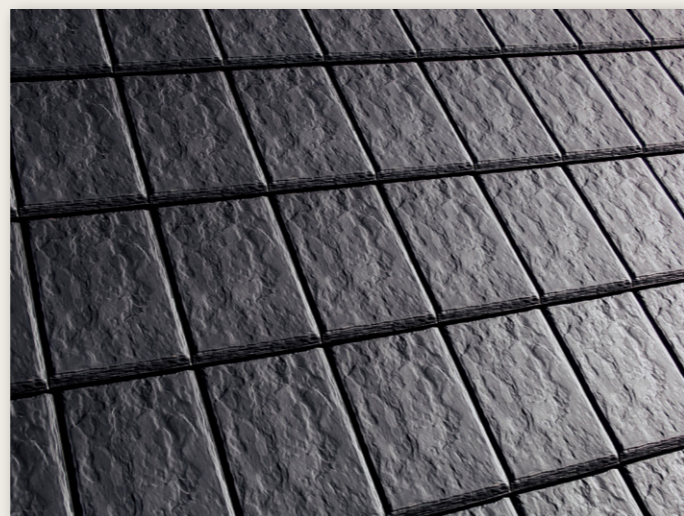

Colocación a junta continua / Continuous joint placement / Pose a joint continu  
Impermeabilizar siempre / Waterproofing required / L'Imperméabilisation nécessaire

Nota: La reproducción de los colores es aproximada y está sujeta a cambios debidos a los colores naturales de las arcillas.

Note: The colour reproduction is approximate and is subject to change due to the natural colours of clays.

Note: La reproduction des couleurs est approximative et est soumise aux changements d'us aux couleurs naturelles des argiles.

## Piezas especiales / Accessories / Accessoires

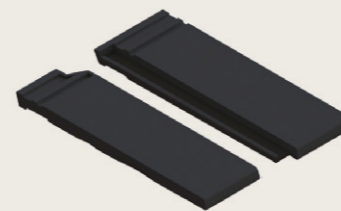

Medias Flat 10 Izq-Der / Half Flat 10 Left-Right /  
Demi-tule Flat 10 Gauche-Droite

1,20 kg. / 2,10 kg.  
45 x 12/16,2 x 2,4 cm.  
1,4 ml. / 1,3 ml.

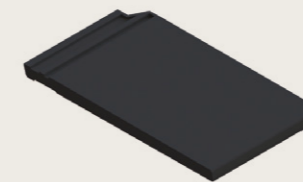

Teja Flat 10 Sin solape / Flat 10 No interlocking /  
Flat 10 Sans emboîtement

3,55 kg.  
45 x 25 x 2,4 cm.  
1,4 ml. / 1,3 ml.



Ventilación Flat 10 / Flat 10 Ventilation /  
Chatière Flat 10

4,50 kg.  
45 x 28,7 x 7,5 cm.

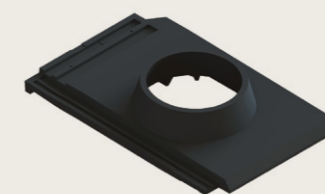

Soporte chimenea Flat 10 / Flat 10 Chimney Carrier /  
Tuile à douille Flat 10

4,1 kg.  
45 x 28,7 x 7,8 cm.  
15,1 cm. (d. int.)



Tapón Universal Ventilación / Universal Ventilation Cap /  
Chapeau Universel

1,70 kg.  
24,5 (d ext.) x 22 (d int.) x 6 cm.

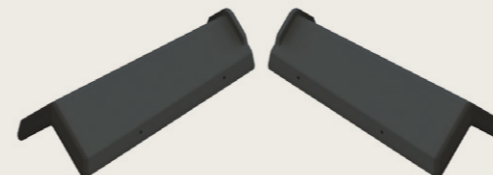

Lateral Recto Flat Agujeros izq-der. / Flat Straight Edges  
Left-Right Edges / Rives à Rabat Flat pré-percé gauche-droite

2,50 kg.  
40,4 x 12,4 x 12,4 cm.  
2,8 / 2,6 ml.

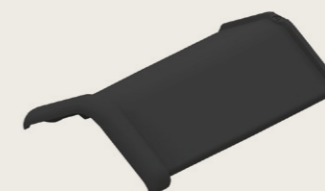

Caballete Angular / Angular Ridge /  
Faîtière Angulaire

3,15 kg.  
42 x 31 x 9,7 cm.  
2,5 ml.



3 Vias Angular / Angular 3 Ways /  
Poinçon 3 Voies Angulaire

4,37 kg.  
45,1 x 29,3 x 10 cm.

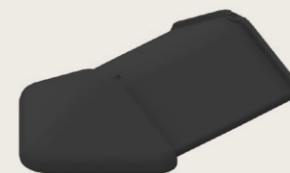

Final Limatesa Angular / Angular Hip Starter /  
About Arêtier Angulaire

2,83 kg.  
42,2 x 29,3 x 10 cm.



Tapón Lateral Universal Angular / Universal Straight  
End Cap / Fronton Rive à rabat Universelle Angulaire

2,65 kg.  
8,5 x 28,5 x 12,5 cm.

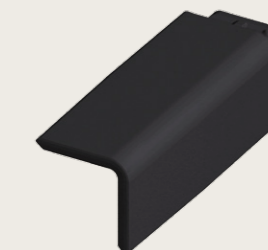

Lateral de Plana Universal / Universal Angular Edge /  
Rive Angulaire Universelle

3,00 kg.  
43 x 9,5 x 9,5 cm.  
2,5